

YEACODE

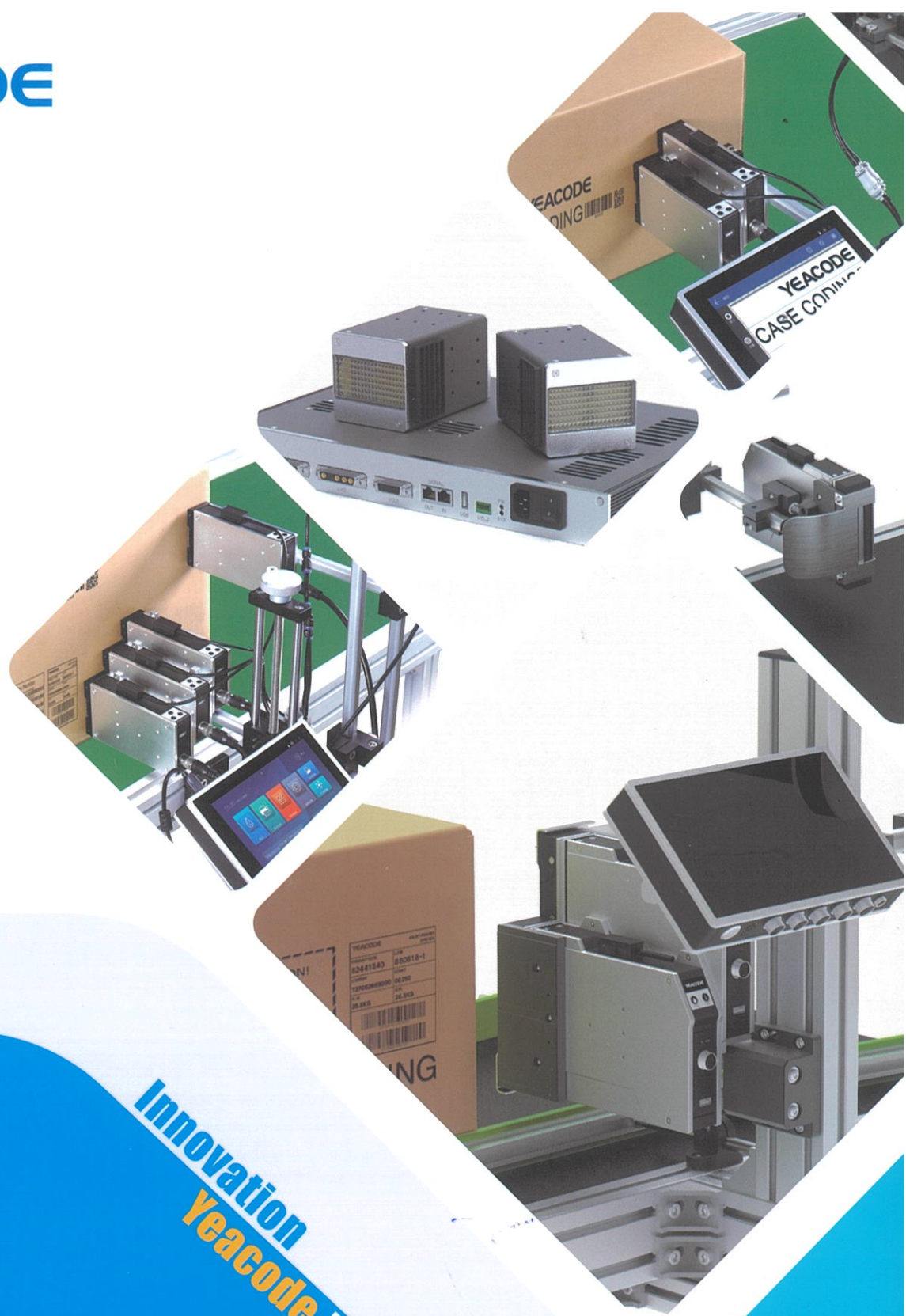

Innovation
Yeacode Leads

Yeacode (Xiamen) Inkjet Inc.

SO-SAL-3200-054

8A Series Printhead

- 32.4mm Print height for single printhead;
- Flexibly combine、group、separate, up to 128mm print height;
- Support downward and sideward

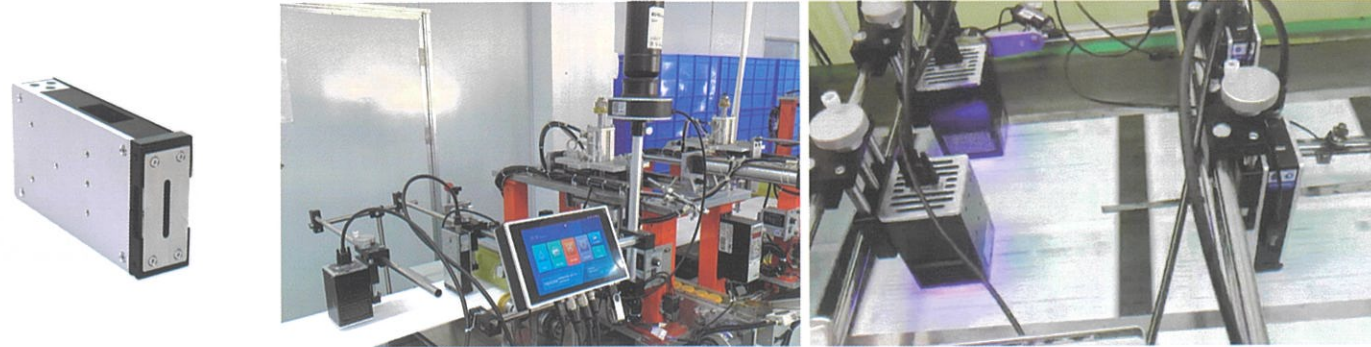

8B Series printhead

- 71.8mm Print height for single printhead;
- Flexibly combine、group、separate, up to 280mm print height;
- Support downward and sideward

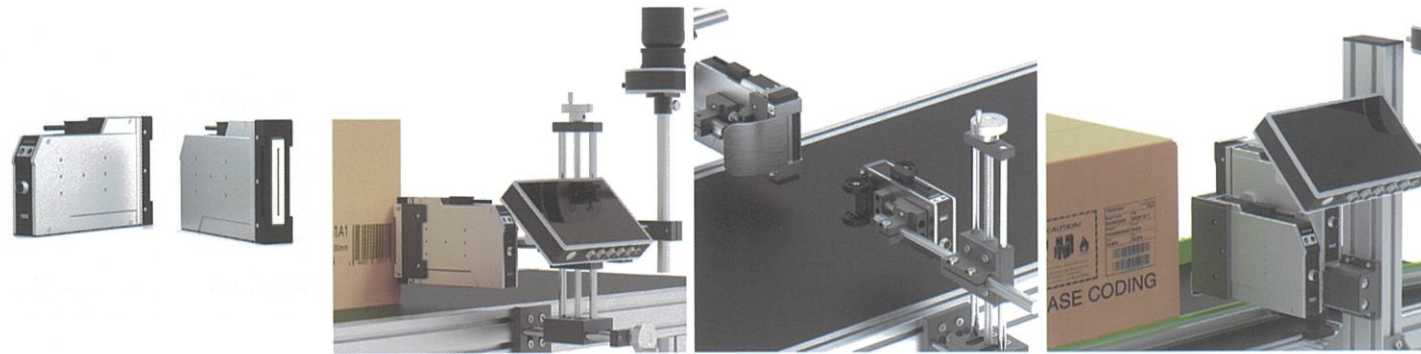

Specifications

Model	8A	8B
Technology	Piezoelectric Printing	
Print Engine	Ricoh	SEIKO
Print Speed	55 meter/min (3 Level darkness)	1-55 meter/min (180DPI)
Throw Distance	0-5mm (Optimum)	
Resolution	Vertical : 300DPI, Horizontal : 150-1200DPI	Vertical: 180DPI, Horizontal : 180/300/360DPI
Print Height	32.4mm for single head, up to 128mm max	71.8mm for single head, up to 280mm max
Ink Supply	Negative Pressure Continuous Ink Supply System(CISS) [Globally Patented]	
Print Orientation	Sideward/Downward;	
Ink	UV ink, Oil-based;	
Ink Management	Auto identify ink type and info, auto track ink usage.	
Working Temperature	9°F (15°C) -104°F(40°C)	
Storage Temperature	41°F (5°C) -113°F (45°C)	
Hardware Dimensions	172*87*38mm	226.5*144*43.5mm
Certifications	CE、FCC	

Meet Every need in Case coding

- ☞ Any size: print height of 71.8mm single head, 280mm Max for stitched head
- ☞ Any substrate: Porous corrugated carton and Non-porous laminated carton
- ☞ Free combination: Multiple-sides printing simultaneously

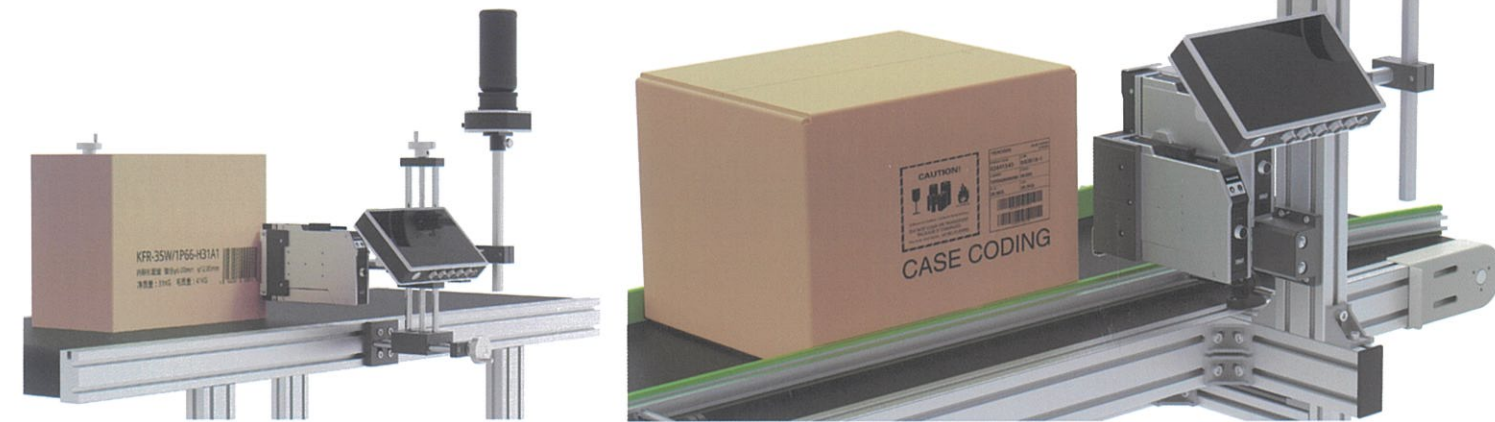

Flexible for Various Applications

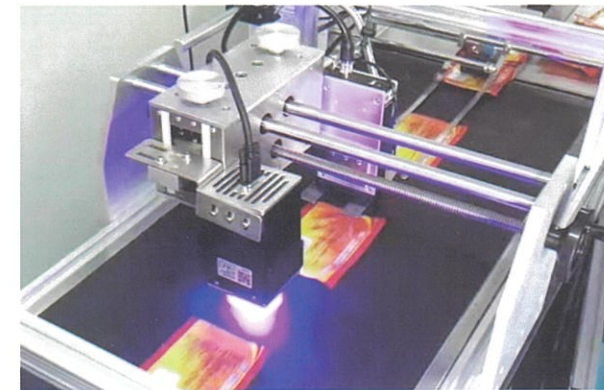

- ☞ Modular design: One-to-One pairing of UV LED
- ☞ Various Spec: Flexible combination of printheads with 32.4mm, 71.8mm
- ☞ Centralized control : Up to 16 printheads
- ☞ Substrate Compatibility: Porous and Non-porous materials

Mounting Modules

Various adjustment modules and anticollision module provide an easy solution to most common installation needs.



Stainless steel anti-collision plate



Rebound Module



Downward Adjustment Module

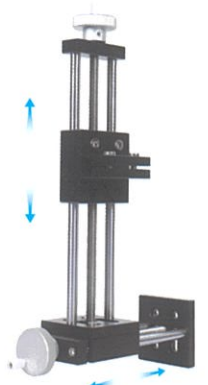

Double Axis Adjustment Module



81 Series Inkjet Printer

Yecode 81 series High-resolution Piezo inkjet printer allows to connect single 8A or 8B printhead, also supports working with UV curing system. It provides various software and hardware interfaces and a complete SDK protocol for integrated development needs.



84 Series Inkjet Printer

Yecode 84 series High-resolution Piezo Inkjet printer allows to connect up to four 8A or 8B printheads, also supports working with UV curing system. It provides various software and hardware interfaces and a complete SDK protocol for integrated development needs.



Used-friendly Interface

8-inch capacitive color touchscreen, Android based interface, easy access to core functions, support various language and input methods.



Variable Data Printing

Support a wide range of variable data: linear barcode, matrix barcode, date & time, shift, counter, image, database, table.



Matrix Barcode



Linear Barcode



Shift



Counter



Date & Time



Database



Continuous Ink Supply System (CISS)

Globally patented negative pressure continuous ink supply system makes it more simple, reliable, and Easy to maintain;
Large-capacity centralized ink supply for multiple printheads from single ink bottle greatly reduce the cost of ink usage;
Encrypted smart-chip on ink cartridge prevent illegal ink usage;

Various software/hardware interface

Provide software development kits, and support various hardware interfaces (PLC, RS232, RS485, Ethernet, etc.) to fulfill various integration needs.



SDK



PLC



RS232



RS485

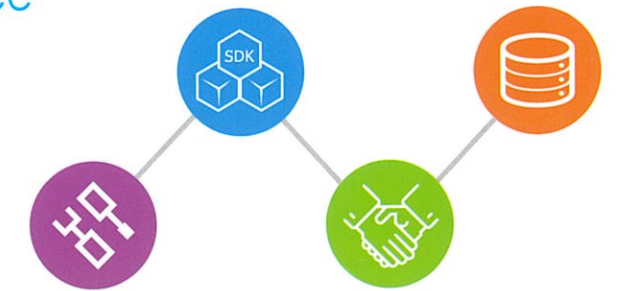

Meet Customized Needs

Open platform and advanced system structure enable quick response to customized printing needs through plug-ins and updates.



Date & Time



010
Numeral System



Source

SDK Development Kit

- Support multiple development languages
- Support various hardware interfaces
- Enable easy and quick integration
- Provide DEMO debugging tool with multiple protocols



C#



TCP



Http



RS232



C++



PHP



Python



Java

PC Software

- Message editing , conveniently start printing
- Remotely control device
- Concurrently manage multiple printers
- Printing preview function for quick development





951 UV Curing Device

- Connectable lamp qty: 1
- Output power: 500W
- Control mode: Printer centralized control
- System integration: Open framework and communication protocol

952 UV Curing Device

- Connectable lamp qty: 2, Cascadable
- Output power: 500W for single channel, 1000W for dual channel
- Control mode: Printer centralized control
- System integration: Open framework and communication protocol



921 UV Curing Device

- Connectable lamp qty: 1
- Output power: 250W
- Control mode: Printer centralized control
- System integration: Open framework and communication protocol

924 UV Curing Device

- Connectable lamp qty: 4, Cascadable
- Output power: 250W for single channel, 1000W for dual channel
- Control mode: Printer centralized control
- System integration: Open framework and communication protocol

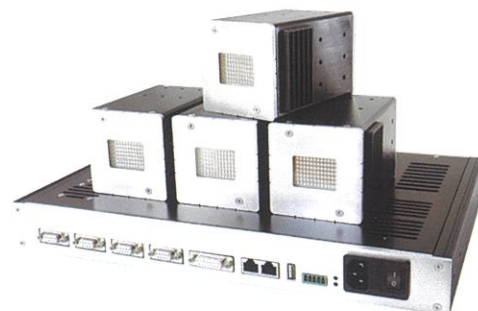

UV LED Lamp



9LH3474

Applicable Printhead: 8B, 8A
Curing Power: 500W
Illumination length: 34mm
Illumination Height: 74mm



9LH7434

Applicable Printhead: 8A
Curing Power: 500W
Illumination length: 74mm
Illumination Height: 34mm



9LH3734

Applicable Printhead: 8A
Curing Power: 250W
Illumination length: 37mm
Illumination Height: 34mm



9LH2536

Applicable Printhead: 8A
Curing Power: 200W
Illumination length: 25mm
Illumination Height: 36mm



Specifications

Model	81Series	84Series
Operating System	Android(Controller), Windows(PC).	
Ports	1) 1 printhead connecting port 2) 2 USB ports 3) I/O_1: Tricolor light, PLC, RS485 4) I/O_2: Encoder, photocell, RS232 5) Ethernet	1) 4 printhead connecting ports 2) 2 USB ports 3) I/O_1: Tricolor light, PLC, RS485 4) I/O_2: Encoder, photocell, RS232 5) Ethernet
Display	8-inch industrial capacitive color touchscreen, resolution 1280*800	
Power	110-240V In, 24V 5A Out	
Working Temperature	9°F (15°C) -104°F (40°C)	
Storage Temperature	41°F (5°C) -113°F (45°C)	
Hardware Dimensions	222*143*38mm	
Certifications	CE、FCC	
Language	English(Default), Chinese, and support custom installation.	
Fonts	DroidSansFallback, Arial, and support custom installation of any ttf format font.	
Input Methods	Support any custom installation of Android input method.	
Object Type	Text, Barcode, Image, Shape, Table.	
Source Type	Text, Date&Time, Shift, Counter, Manufacture Info, Database Text, Dynamic Text, Database Image, Dynamic Image, Company Logo.	
Barcode Types	Linear Barcodes: C25INTER、EAN8/EAN13、GS1 EAN128、CODE39、CODE93、CODE128、CODE128A、CODE128B、CODE128C、UPCA、UPCE、ITF14、RSS14、RSS14STACK、RSS14STACK_OMNI、RSS_LTD、RSS_EXP、RSS_EXPSTACK; Matrix Barcodes:QRCODE、GS1 QRCODE、PDF417、DataMatrix、GS1 DataMatrix、GridMatrix、AZTEC Code;	
Database	Text、Excel、Access、SQL Server	



About Yeacode

Yeacode (Xiamen) Inkjet Inc. was founded by a group of industrial inkjet professionals. With our expertise and knowledge in coding and marking, we focus on developing and providing the most cost effective and highest quality industrial high resolution inkjet printers.

Our innovative modular printer design enables flexible combination of up to 16 printheads to support different print heights and concurrent printing of multiple messages. Each of the printheads can be paired with one of our special designed UV LED illuminating head to provide an economic and environmental friendly printing solution for non-porous substrates. With our experienced team of R&D professionals and the well structured software system, we are able to quickly response to customized and integration needs.

Yeacode focuses on industrial high resolution inkjet printers, and aims to become your professional and innovative partner.



Pursuit of excellence
Developing by innovation

YEACODE

Yeacode (Xiamen) Inkjet Inc.

4th Floor, No. 63-2 Wanghai Road,

+86-592-5221159

sales@yeacode.com

www.yeacode.com

